

# User Manual

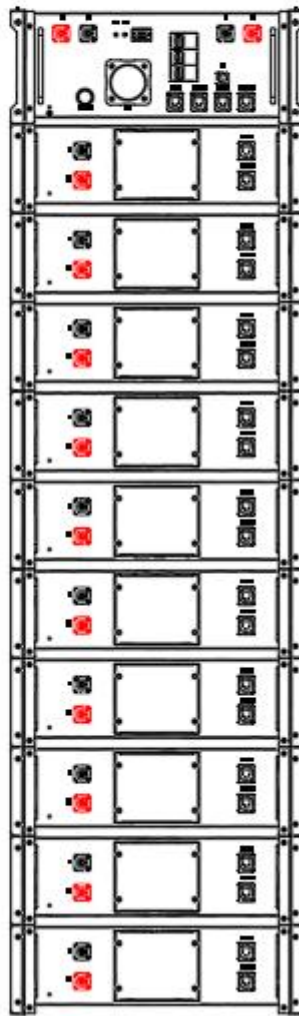
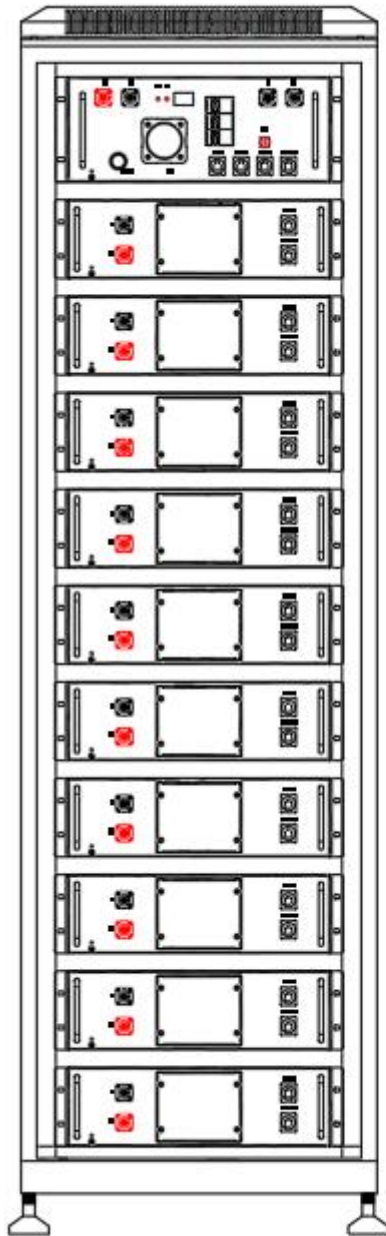

## CONTENT

1. Important information in the manual.....	3
1.1 Scope.....	3
1.2 Description of YP-HV 20-50.....	
... 31.3 Meaning of symbols.....	
... 41.4 General safety information.....	
... 61.5 Disclaimer.....	
... 61.6 Quality Certificate.....	
... 1.7 Requirements for Installation Personnel.....	8
2. Safety.....	8
2.1 Safety rules.....	8
2.2 Safety information.....	9
3. Transport to the end customers.....	9
3.1 Provisions on Shipping of Battery Modules.....	9
4. Preparation.....	11
4.1 Safety Gear.....	11
4.2 Installation tools.....	11
5. Description and installation of YP-HV 20-50 battery.....	12
5.1 Installation precautions.....	12
5.2 YP-HV 20-50 product description.....	12
5.3 Product data.....	13
5.4 Description of rack.....	14
5.4.1 3U-HRack Parts description.....	14
5.5 Description of Battery Module.....	15
5.6 Description of High-Voltage Control Box.....	17
5.7 Cabinet-type battery pack installation.....	17
5.8 Installation of bracket type battery pack.....	18
6.YP-HV 20-50User Interface .....	22
6.1. User mode.....	22
6.2 Engineering mode.....	23
6.3 Individual voltage.....	23
6.4 Monomer temperature.....	23
6.5 Relay Status.....	24
6.6 Charging Information.....	24
6.7 Others.....	25
6.8 set up.....	26
6.9 Fault information interface .....	26
7. Maintenance and upgrade.....	27
8. Disposal.....	28

# 1.Important information in the manual

## 1.1 Scope

The installation and operation manual applies to the modular battery energy storage system. Please carefully read this installation and operation manual to ensure the safe installation, preliminary debugging, and maintenance of YP-HV 20-50. Installation, preliminary debugging, and

maintenance must be carried out by qualified and authorized personnel. Please keep this installation and operation manual and other applicable documents near the battery energy storage system, so that all personnel involved in installation or maintenance can access this installation and operation manual at any time.

This installation and operation manual only applies to countries meeting the certification requirements. Please observe the applicable local laws, regulations, and standards. Standards and legal provisions of other countries may be inconsistent with the provisions and specifications in this manual. In this case, please contact our after-sales service personnel.

## 1.2 Description of YP-HV 20-50

Model	System energy (kWh)	Composition
YP-HV 20-50	20.5	TH-51100R-HV*4+MCB750V*1
	25.6	TH-51100R-HV*5+MCB750V*1
	30.72	TH-51100R-HV*6+MCB750V*1
	35.84	TH-51100R-HV*7+MCB750V*1
	40.96	TH-51100R-HV*8+MCB750V*1
	46.08	TH-51100R-HV*9+MCB750V*1
	51.2	TH-51100R-HV*10+MCB750V*1

## 1.3 Meaning of Symbols

This manual contains the following types of warnings:



**Danger!** It may cause an electric shock.

Even when the equipment is disconnected from the power grid, the voltage-free state will have a time lag.



**Danger!** If the instructions are not observed, death or severe injury may occur.



**Warning!** If the instructions are not observed, a loss may occur.

**Attention!** This symbol represents information on the device use.

### Symbols on equipment:

The following types of warning, prohibition, and mandatory symbols are also used on the equipment.



**Attention! The risk of chemical burns**

If the battery is damaged or fails, it may lead to electrolyte leakage, which in turn causes the formation of a small amount of hydrofluoric acid, among other effects. Contact with these liquids can cause chemical burns.

- Do not subject the battery module to severe impact.
- Do not open, disassemble or mechanically change the battery module.
- In case of contact with an electrolyte, wash the affected area with clean water immediately and seek medical advice promptly.



**Attention! The risk of explosion**

Incorrect operation or fire may cause the lithium-ion battery unit to ignite or explode, leading to serious injury.

- Do not install or operate the battery module in explosive or high-humidity areas.

- Store the battery module in a dry place within the temperature range specified in the data sheet.
- Do not open, drill through or drop the battery cell or module.
- Do not expose the battery cell or module to high temperatures.
- Do not throw the battery cell or module into the fire.
- If there is a fire from the battery, please use the CO2 extinguisher. If there is a fire near the battery, please use a dry powder extinguisher.
- Do not use defective or damaged battery modules.



**Caution! Hot surface**

- If a malfunction occurs, the parts will become very hot, and touching them may cause serious injury.
- If the energy storage system is defective, please shut it down immediately.
- If the fault or defect becomes obvious, special care should be taken when handling the equipment.



**No open fire!** It is prohibited to handle open flames and ignition sources near the

energy storage system.



**Do not insert any objects into the opening in the housing of the energy storage system!**

No objects, such as screwdrivers, may be inserted through openings in the casing of the storage system.



**Wear safety goggles!** Wear safety goggles when working on the equipment.



**Follow the manual!** When working and operating the equipment, the installation and

operation manual provisions must be observed.

## 1.4 General Safety Information



**Danger!** Failure to comply with the safety information can lead to life-threatening situations.

1. Improper use can cause death. Operators of YP-HV 20-50 must read this manual and observe all safety information.
2. Operators of YP-HV 20-50 must comply with the specifications in this manual.
3. This manual cannot describe all conceivable situations. For this reason, applicable standards and relevant occupational health and safety regulations are always given priority.
4. In addition, the installation may involve residual hazards in the following circumstances:
  - Incorrect installation.
  - The installation is carried out by personnel who did not receive relevant training or guidance.
  - Failure to observe the warnings and safety information in this manual.

## 1.5 Disclaimer

**shall not be liable for personal injury, property loss, product damage and subsequent losses under the following circumstances.**

- Failure to comply with the provisions of this manual.
- Incorrect use of this product.
- Unauthorized or unqualified personnel repair the product, disassembly the rack and perform other operations.
- Use of unapproved spare parts.
- Unauthorized modifications or technical changes to the product.

## 1.6 Proper Use

- The battery energy storage system can only be installed and operated in an enclosed space. The working environment temperature range of YP-HV 20-50 is  $-20^{\circ}\text{C} \sim 55^{\circ}\text{C}$ , and the maximum humidity is 85%.

The battery module shall not be exposed to the sun or placed directly beside the heat source.

- The battery module shall not be exposed to a corrosive environment.
- When installing the battery energy storage system, ensure that it stands on a sufficiently dry and flat surface with sufficient bearing capacity. Without the manufacturer's written approval, the installation site's altitude shall not be higher than 2,000 meters. The output power of the battery decreases with the altitude.
- In areas where flooding may occur, care must be taken to ensure that the battery module is installed at a suitable height and to prevent its contact with water.
- The battery energy storage system must be installed in a fireproof room. This room must have no fire source and must be equipped with an independent fire alarm device, which complies with local applicable regulations and standards. According to local applicable regulations and standards, the room must be separated by the T60 fire door. Similar fire-proof requirements apply to other openings in the room (such as windows).

**Compliance with the specifications in this manual is also part of proper use.**

**The use of the YP-HV 20-50 system is prohibited in the following circumstances:**

- Mobile use on land or in the air (use on water only with the manufacturer's consent and with the manufacturer's written consent).
- Used in medical devices.
- Used as a UPS system.

## 1.7 Requirements for Installation Personnel

All work shall comply with local applicable regulations and standards.

The installation of YP-HV 20-50

can only be completed by electricians with the following qualifications:

- Trained in dealing with hazards and risks associated with the installation and operation of electrical equipment, systems, and batteries.

- Trained on installation and debugging of electrical equipment.
- Understanding and complying with the technical connection conditions, standards, guidelines, regulations, and laws applicable.
- Knowledge of handling lithium-ion batteries (transportation, storage, disposal, hazard source).
- Understanding and complying with this document and other applicable documents.

## 2. Safety

### 2.1 Safety rules

To avoid property damage and personal injury, the following rules shall be followed when working on the hazardous live parts of the battery energy storage system:

- It is available for use.
- Ensure that it will not restart.
- Make sure there is no voltage.
- Grounding protection and short circuit protection
- Cover or shield adjacent live parts.

### 2.2 Safety information

Part damage or short circuit may cause electric shock and death. A short circuit can be caused by connecting battery terminals, resulting in current flow. This type of short circuit shall be avoided under any circumstances. For this reason, follow these instructions:

- Use insulated tools and gloves.
- Do not put any tools or metal parts on the battery module or high-voltage control box.
- When operating the battery, be sure to remove watches, rings, and other metal objects.
- Do not install or operate this system in explosive or high-humidity areas.
- When working on the energy storage system, first turn off the charging controller, then the battery, and ensure that they are not turned on again.

**Improper** use of the battery energy storage system can lead to death. The use of the battery energy storage system beyond its intended use is not allowed, because it may cause great danger. **Improper** handling of the battery energy storage system can cause life-threatening risks, serious injury or even death.



 **Warning!** Improper use can cause damage to the battery cell.

- Do not expose the battery module to rain or soak it in liquid.
- Do not expose the battery module to a corrosive environment (such as ammonia and salt).
- The battery energy storage system shall be debugged no later than six months after delivery.

### 3. Transport to the end customers

#### 3.1 Provisions on Shipping of Battery Modules:

It is necessary to comply with the relevant regulations and provisions on roads for shipping lithium-ion products in the corresponding countries.



It is prohibited to smoke in the vehicle during transportation or in the vicinity during loading and unloading.



The dangerous goods transport vehicles shall meet relevant regulations concerning road transportation and shall be equipped with two tested CO<sub>2</sub> fire extinguishers.



It is forbidden for the freight forwarder to open the outer package of the battery module. Use only approved lifting equipment to move the battery cabinet system. Use only the hanging lug on the top of the battery cabinet as the connection point. When lifting, the angle of the sling must be at least 60°.



Improper vehicle transportation can cause injury. Improper transportation or improper transportation locks may cause the load to slip or overturn, resulting in injury. The cabinet shall be placed vertically to prevent it from sliding in the vehicle, and a fixing belt shall be used.



The battery energy storage system can be damaged, if not properly transported. The battery module can only be transported vertically. Note that these parts may be top-heavy. Failure to follow this instruction may result in damage to the part.



During transportation, the battery storage rack may be damaged when it is installed with the battery module. The battery storage rack is not designed to be transported with the installed battery modules. Always transport the battery module and the battery rack separately. Once the battery module is installed, do not move the battery rack, and do not lift it by a lifting device.



If possible, do not remove the transport packaging before arrival at the installation site. Before removing the transport protector, check if the transport packaging is damaged, and check the impact indicator on the outer packaging of the battery converter. If the impact indicator is triggered, the possibility of transport damage cannot be ruled out.



Improper transportation of battery modules may cause injury. The single battery module weighs 48 kg. If it falls or slips, it may cause injury. Only use suitable transport and lifting equipment to ensure safe transport.



Wear safety shoes to avoid the danger of injury. When transporting the battery rack and battery module, their parts may be crushed due to their heavy weight. Therefore, all persons involved in transportation must wear safety shoes with toe caps. Please observe the safety regulations for transportation at the end customer's site, especially during loading and unloading.



During transportation and installation of unpacked battery storage cabinets, the risk of injury increases, especially on sharp metal panels. Therefore, all personnel involved in transportation and installation must wear protective gloves.



The maximum weight of a single rack of YP-HV 20-50 can reach 550 kg.

We suggest that at least 2-3 people work together to install the battery rack.

The lifting device is helpful for heavy parts,



and the pulley or cart for light parts. Be careful not to damage the case. The number of battery modules stacked shall not be more than 10.

## 4. Preparation

### 4.1 Safety Gear

			
<b>Insulated gloves</b>	<b>Safety goggles</b>	<b>Safety shoes</b>	<b>Helmet</b>

### 4.2 Installation tools

			
<b>electric hand drill</b>			

## 5. Description and installation of YP-HV 20-50 battery

### 5.1 Installation Precautions

**STOP** **WARNING! Possible damage to the building due to static overload**

1. The total weight of the battery storage system is 550kgs. Ensure that the installation site has sufficient bearing capacity.
2. When selecting the installation site, consider the transportation route and necessary site cleanup.

### 5.2 YP-HV 20-50 Product Description



YP-HV 20-50 is a high-voltage lithium-ion battery system.

It provides a reliable backup power supply for supermarkets, banks, schools, farms and small factories to smooth the load curve and achieve peak load transfer. It can also improve the stability of renewable systems and promote the application of renewable energy.





















It is characterized by high integration, good reliability, long service life, wide working temperature range, etc. The battery energy storage system is modular. Each battery module has a capacity of 5.12 kWh. It can support up to 10 battery modules in series. Its total energy can be expanded from 20.5 kWh to 51.2 kWh.

### 5.3 Technical Data

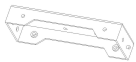
Main Parameter							
Cell Chemistry	LiFePO4						
Module Energy (kWh)	5.12						
Module Nominal Voltage (V)	51.2						
Module Capacity (Ah)	100						
Cell model/Configuration	64S1P	80S1P	96S1P	112S1P	128S1P	144S1P	160S1P
System Nominal Voltage (V)	204.8	256	307.2	358.4	409.6	460.8	512
System Operating voltage (V)	172.8~224	215~280	259.2~336	302.4~392	345.6~448	388.8~504	432~560
System Energy (kWh)	20.48	25.6	30.72	35.84	40.96	406.08	51.2
Charge/Discharge Current (A)	Recom mend	50					
	Max	100					
Working Temperature (°C)	Charge: 0~55/Discharge: -20~55						
Communication Port	CAN2.0						
Humidity	5~85%RH Humidity						
Altitude	≤2000 m						
IP Rating of Enclosure	IP20						
Rack size (W/D/H,mm)	538*492*791	538*492*941	538*492*1091	538*492*1241	538*492*1391	538*492*1541	538*492*1691
Weight Approximate (kg)	200	245	290	335	380	425	470
Cabinet size (W/D/H,mm)	600*600*1000	600*600*1200	600*600*1400	600*600*1600	600*600*1800	600*600*2000	600*600*2000
Weight Approximate (kg)	255.5	302	309	428	473	525.5	572.5
Installation Location	Rack Mounting						
Storage Temperature (°C)	0~35						
Recommend Depth of Discharge	90%						
Cycle Life	25±2°C, 0.5C/0.5C, EOL70%≥6000						

## 5.4 Description of Rack

### 5.4.1 3U-HRack Parts description

				
A	B	C	D	E
				
F	G	H	I	J
				
K	L	M	N	O
				
P	Q	R	S	T
				
U				

No.	Description	Notes
A	Battery Pack	
B	Main control box	
C	Tandem wiring harness	
D	Positive connection	
E	Negative connection	
F	Inverter communication line	
G	Series communication line	
H	operation instructions	
I	Cabinet screws	
J	Positive output line	
K	Negative output line	
L	4U Stacking bracket for main control box	*Optional accessories, purchased without the need for a cabinet
M	Main control box transparent acrylic plate fixing bracket	
N	Main control box transparent acrylic plate	
O	3U battery Pack stacking bracket	
P	battery Pack transparent acrylic plate fixing bracket	
Q	battery Pack transparent acrylic plate	
R	M5 large flat head screw	
S	M5 external hexagonal combination screw	
T	M4 large flat head screw	
U	Matching Resistor	

## 5.5 Description of Battery Module

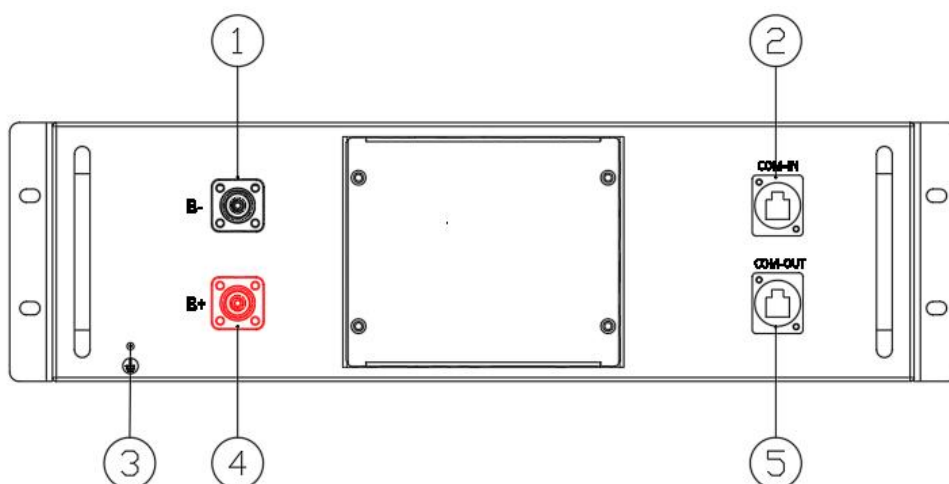

No.	Name	Description
①	B-	Battery module negative pole (black)
②	COM-IN	Connection position of battery module communication
③	Grounding	
④	B+	Battery module positive pole (orange)
⑤	COM-OUT	Connection position of battery module communication

## 5.6 Description of High-Voltage Control Box

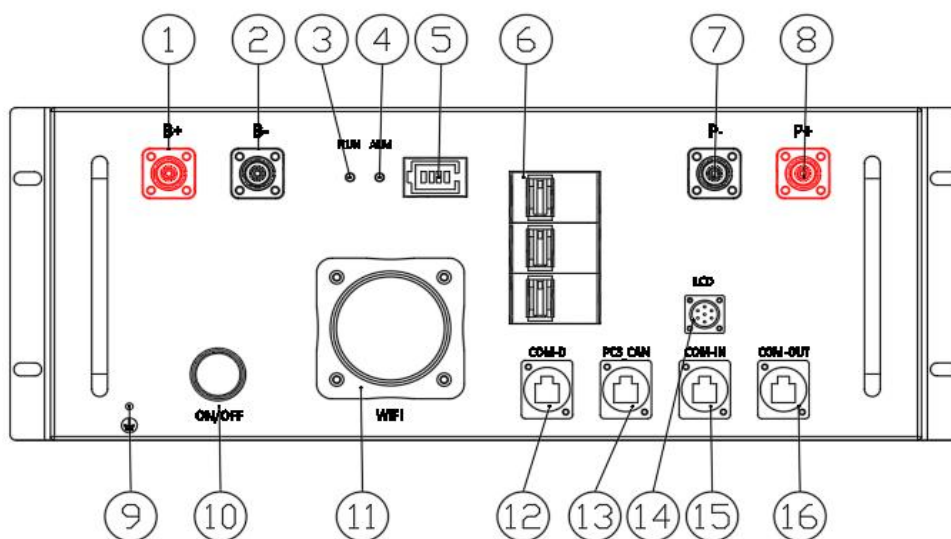

No.	Name	Description
①	B+	Connection position of the common positive pole of the battery(orange)
②	B-	Connection position of the common negative pole of the battery (black)
③	LED	RUN
④	LED	ALM
⑤	LED	CAPACITY
⑥	DC switch	Control battery pack output
⑦	P-	Connection position of PCS negative pole (black)
⑧	P+	Connection position of PCS positive pole (orange)
⑨	Grounding	
⑩	ON/OFF	System start switch
⑪	WIFI	
⑫	COM-D	Debugging port
⑬	PCS_CAN	Communication with inverters
⑭	LCD	Touch screen external interface
⑮	COM-IN	Parallel communication port
⑯	COM-OUT	Communication with battery module

If there is any change in the pin position of the communication line, the customer shall be notified in writing or provided with supporting communication wire.

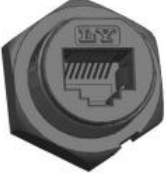
communication		CAN Port foot position definition			
		RJ45 Pin	Definition Description	RJ45 Pin	Definition Description
		1	NC	5	CANL
		2	NC	6	NC
		3	NC	7	NC
		4	CANH	8	NC



## 5.7 Cabinet-type battery pack installation



Insufficient or no grounding may cause an electric shock. Device malfunctions, and insufficient or no grounding may cause device damage and life-threatening electric shocks.

① Remove the cabinet from the packaging wooden box and move it to the installation position. The installation position should be level with the cabinet on the ground and have a certain bearing capacity. After placing the cabinet, screw out the four support feet at the bottom of the cabinet to support it.

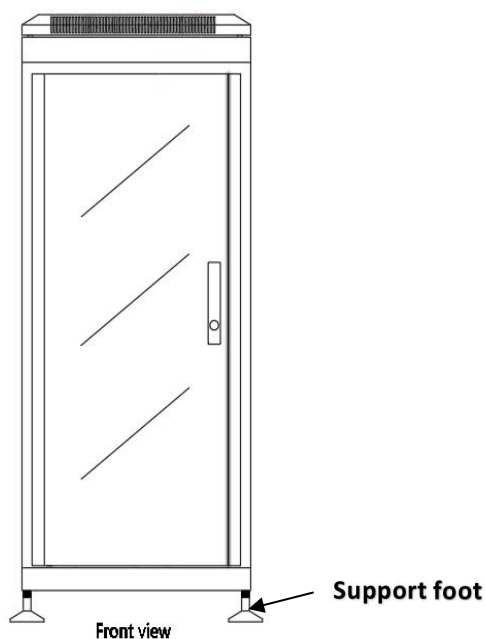

② Open the cabinet door, unpack the battery pack packaging, and place the battery pack in the cabinet with the carrier plate adjusted. (The battery pack is heavy and requires two people to operate simultaneously) Finally, install the main control box, which is located at the top of the cabinet. Fix the mounting brackets on each battery module with M6 screws to prevent the module from shaking or sliding.

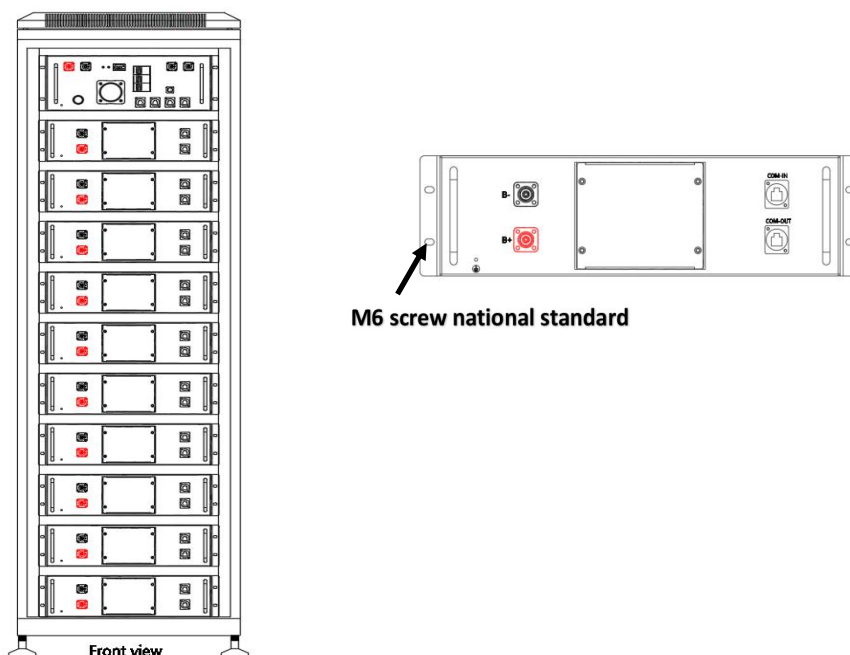

③ Connect the battery pack installed in the cabinet as shown in the figure. Before installing the connecting cable, be sure to wear insulated gloves (do not touch the battery output metal terminals with bare hands). The red connector represents the positive pole, while the black connector represents the negative pole. Connect each battery module in series, then insert the communication cable in sequence and connect the ground wire. Press the ON/OFF key to start the system, turn on the DC switch, and the system will output externally.

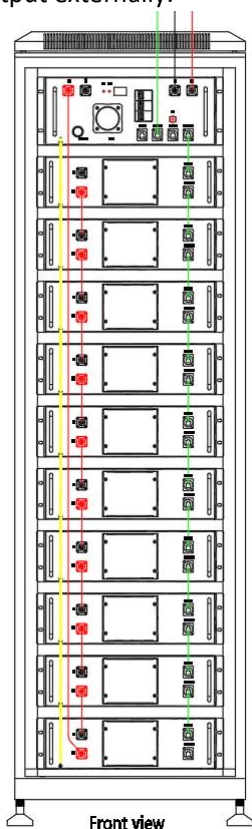

NOTE:

1. Not connect in reverse or other wrong way

2. Each cable adopts a quick plug connector. When unplugging the power plug, you must press this locking button to unplug it.

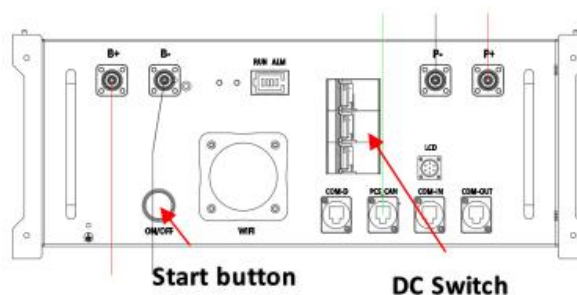

## 5.8 Installation of bracket type battery pack



Insufficient or no grounding may cause an electric shock. Device malfunctions, and insufficient or no grounding may cause device damage and life-threatening electric shocks.

① Firstly, remove the battery pack from the cardboard box and locate the optional accessories. Fix the accessories on the battery pack and main control box with screws. (Note: The battery pack bracket should be shorter than the main control box bracket) as shown in the figure:

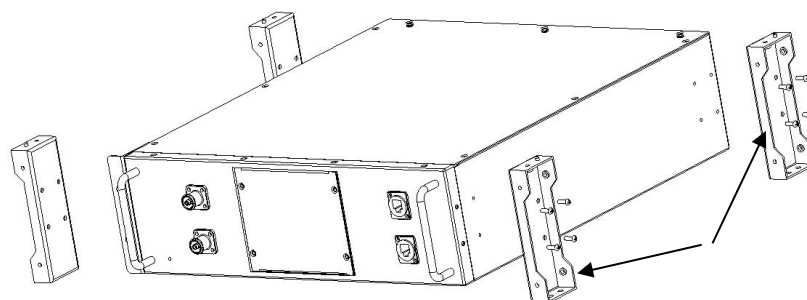

Battery pack

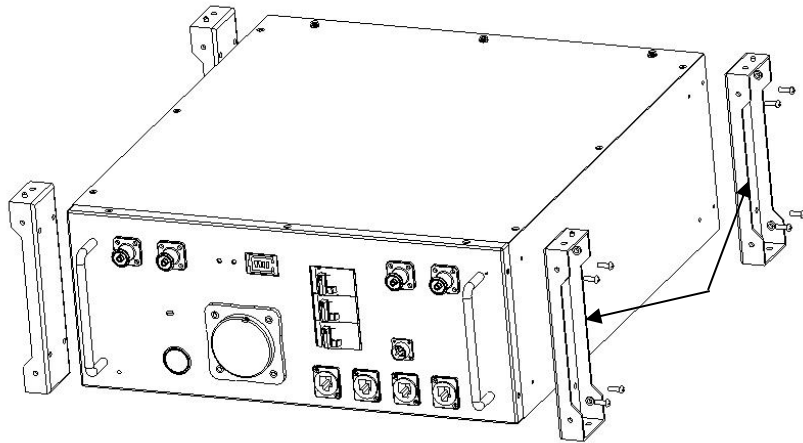

main control box

② After installing the battery pack stacking brackets, place the bottom battery packs on a flat ground and stack them in sequence. Stacking up to 10 battery packs. (Note: The ground must be flat and able to bear weight)

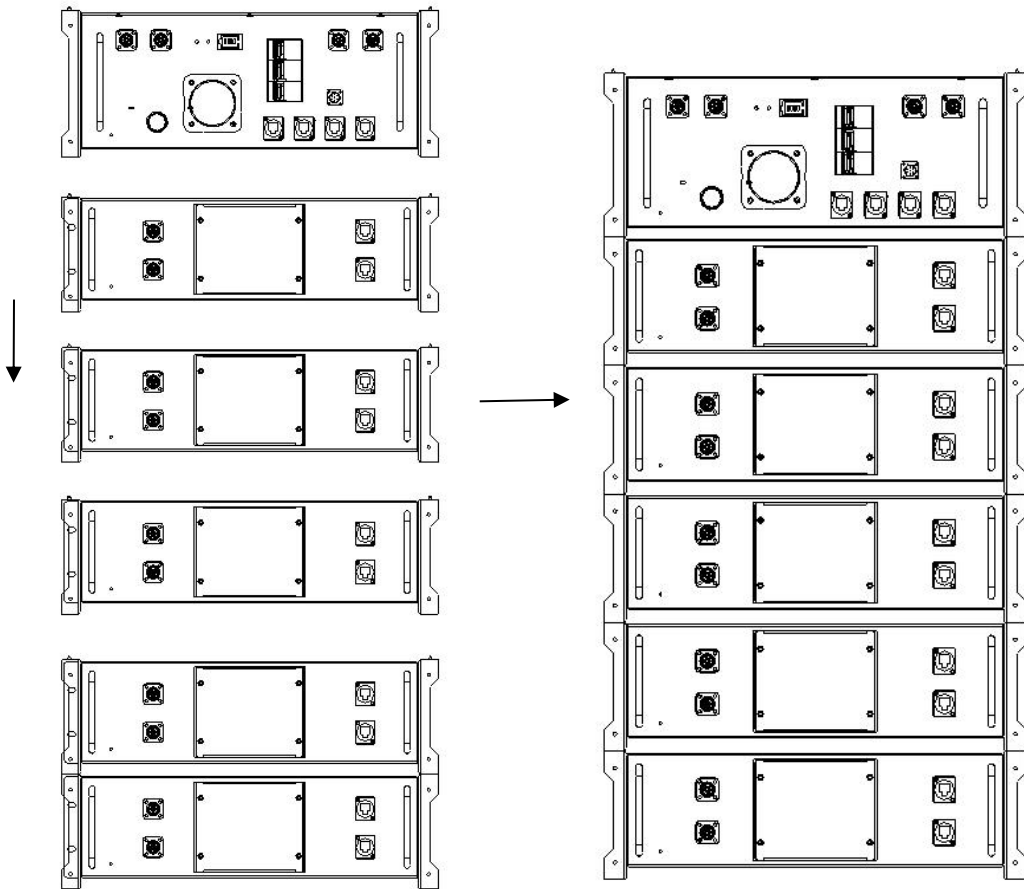

③ After the stacking is complete, fix the battery pack stacking bracket with M5 combination screws.

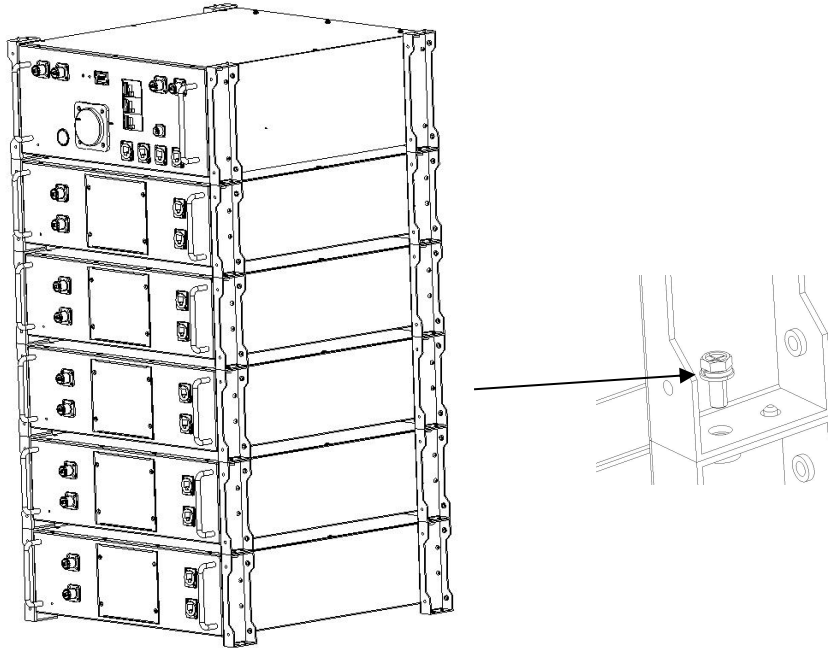

④ Connect stacked battery packs. Before installing the connecting cable, be sure to wear insulated gloves (do not touch the battery output metal terminals with your hands). The red connector represents the positive pole, while the black connector represents the negative pole. Connect each battery module in series, insert the communication cable below and connect the ground wire. Connect the P+P-output line and communication line to the inverter. After checking the wiring, press the ON/OFF key to start the system, turn on the DC switch, and the system will output externally. As shown in the figure:

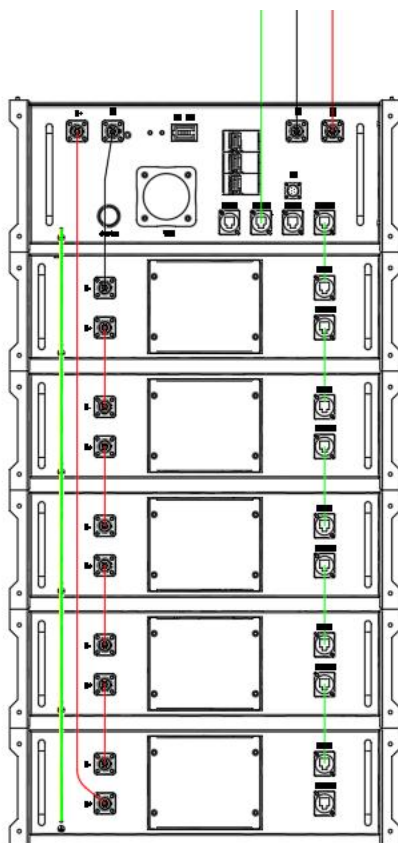

NOTE:

1. Not connect in reverse or other wrong way

2. Each cable adopts a quick plug connector. When unplugging the power plug, you must press this locking button to unplug it.

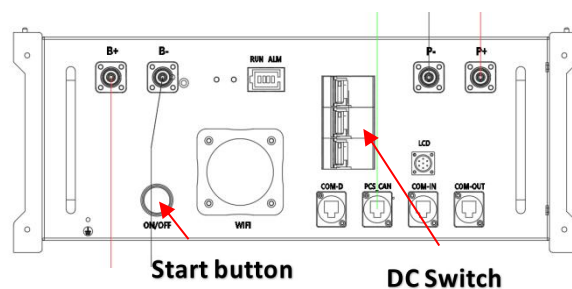
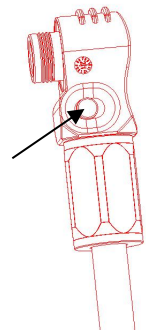

⑤ After the system starts, locate the corresponding accessories. Install the protective cover as shown in the diagram.

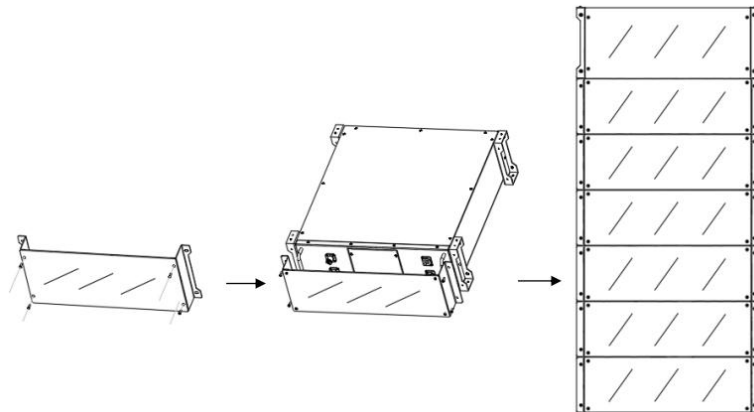

⑥ Each high-voltage box is equipped with a matching resistor, and a single running matching resistor is connected to COM-IN. When multiple machines are connected in parallel, only the COM-IN of the last one needs to be connected with a matching resistor.

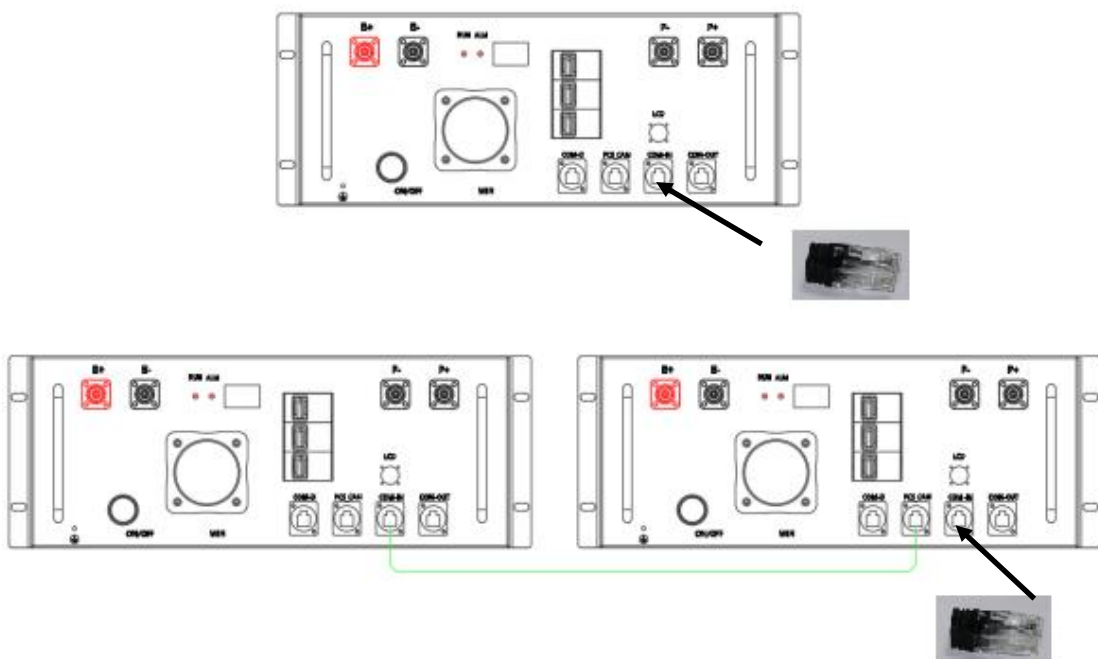

## 6.YP-HV 20-50

### User Interface 6.1. User mode

First boot, enter user mode.

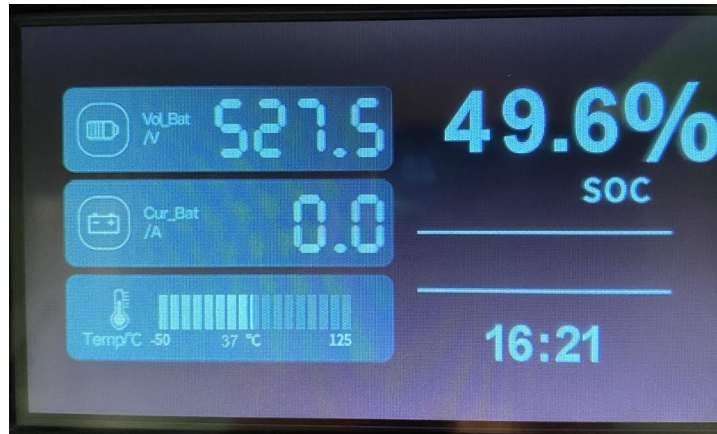

Click anywhere on the screen to pop up the following button, with specific instructions as follows:

Click  Different user mode styles (including day/night mode) can be switched. After selection, if the computer is turned off and restarted, the selected interface will remain inactive Change;

Slide left and right  Adjustable screen brightness;

Click  You can enter engineering mode to view more information;

Click  Return to the interfac

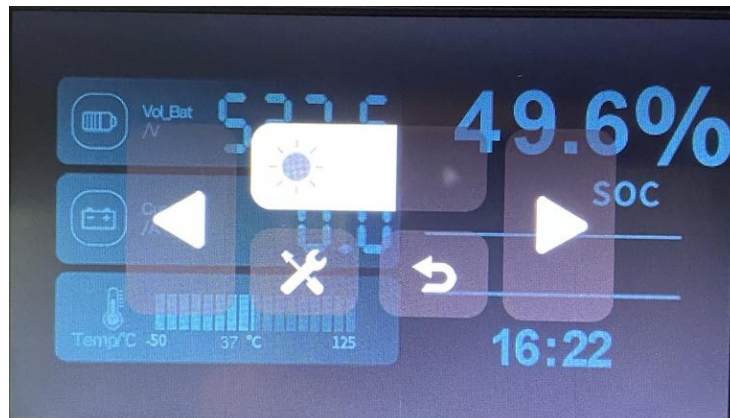



## 6.2 Engineering mode

Enter engineering mode, with the date displayed on the top left, faults displayed between date and time, and time displayed on the right; Central display of total voltage, SOC, total Current, highest voltage, lowest voltage, highest temperature, lowest temperature; The navigation menu is displayed at the bottom, allowing you to switch to viewing interface details.



## 6.3 Individual voltage

Click on [Single Body Voltage] to enter the voltage details interface, where you can slide left and right to view each string of voltage values, and click to  return to the higher-level interface.

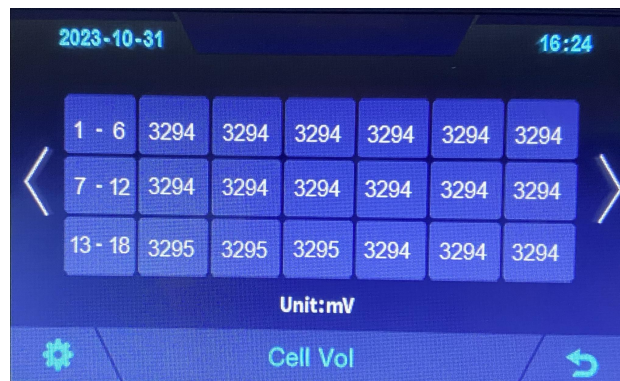

## 6.4 Monomer temperature

Click on [Single Body Temperature] to enter the temperature details interface. You can swipe left and right to view each temperature value, and click to  return to the upper level interface.

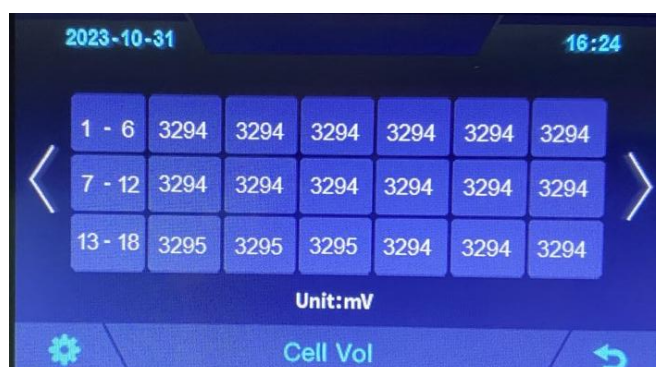

## 6.5 Relay Status

Click on [Relay Status] to enter the relay details interface, including the relay name, open/closed status, and alarm status. You can slide left and right to check For more relay information, click to  return to the higher-level interface.

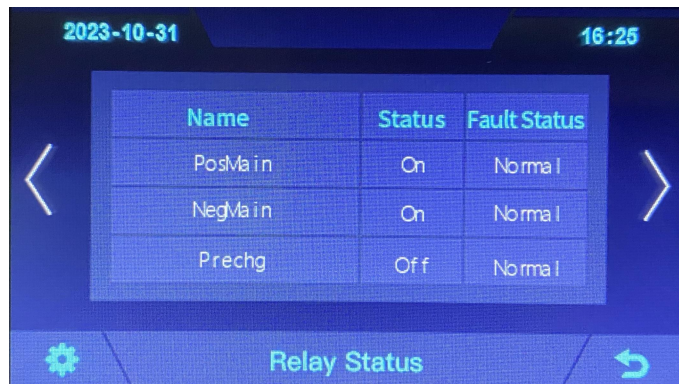

## 6.6 Charging Information

Click on **Charging Information** to enter the charging details interface, where you can view the charged time, BMS request information, and charger information. Click to  return to the superior level Interface.

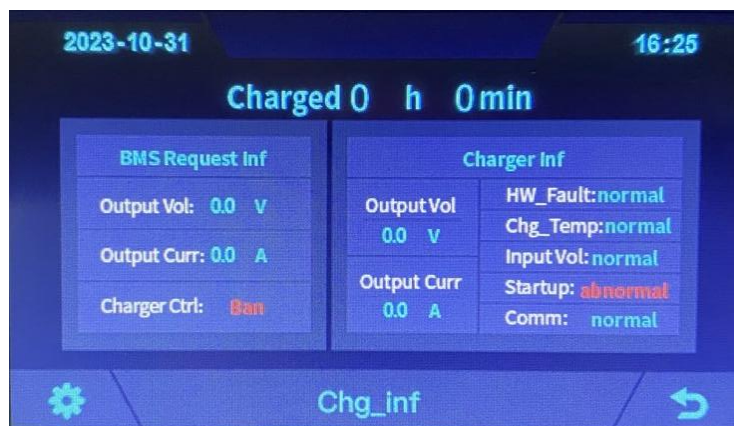

## 6.7 Others

Click [Other] to enter the heating information, insulation resistance value, diagnostic information, and cumulative time information interface. Click each icon to enter the three-level interface View detailed information and click to  return to the higher-level interface.

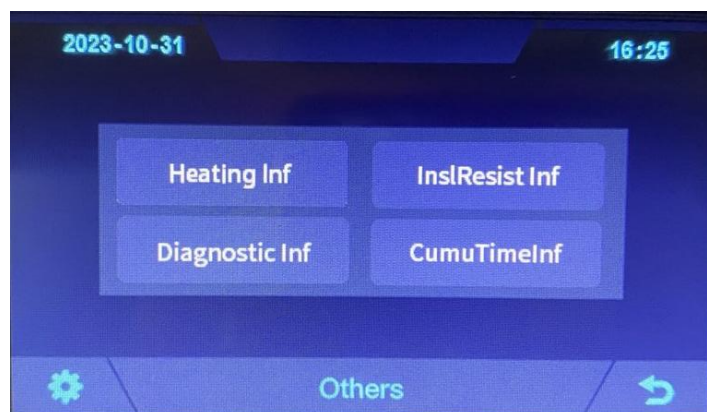



### 6.7.1 Insulation resistance

Click on [Insulation Resistance Value] to enter the insulation details three-level interface, where you can view the positive and negative insulation resistance values. Click to  return to the higher-level interface.

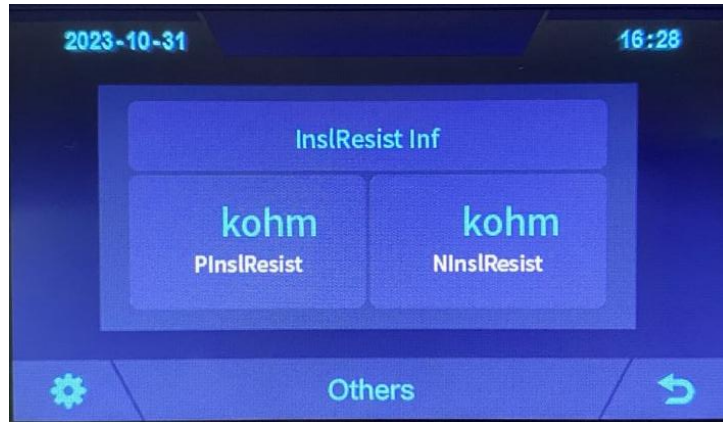

### 6.7.2 Diagnostic Information

Click [Diagnostic Information] to enter the diagnostic details three-level interface, click "Diagnostic Information" to enter the next interface, and click to  return to the higher-level interface.

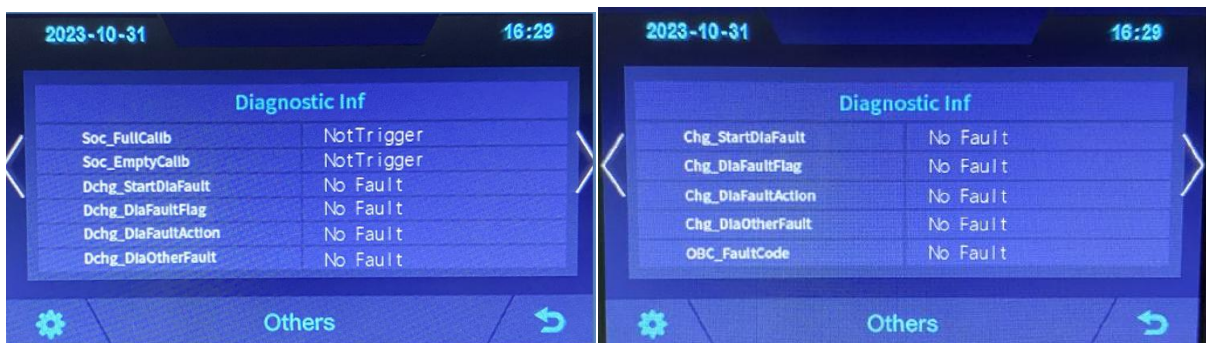
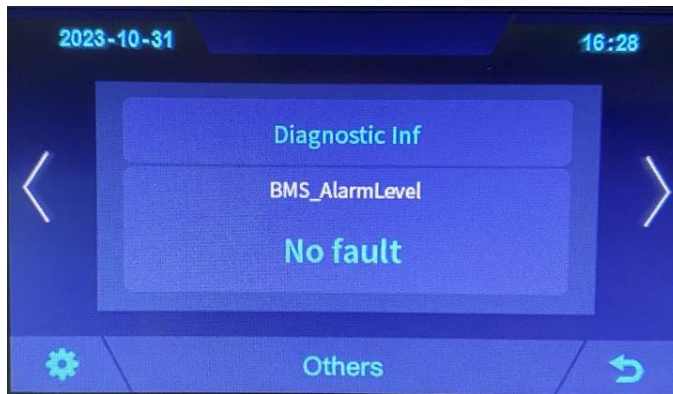

### 6.7.3 Accumulated time information

Click on 'Accumulated Time Information' to enter the third level interface of accumulated time details. You can view the accumulated discharge time and accumulated charging time, and click  back to the previous page level interface.

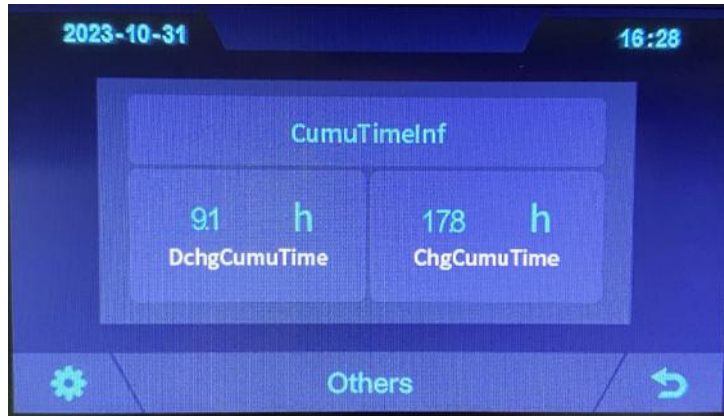

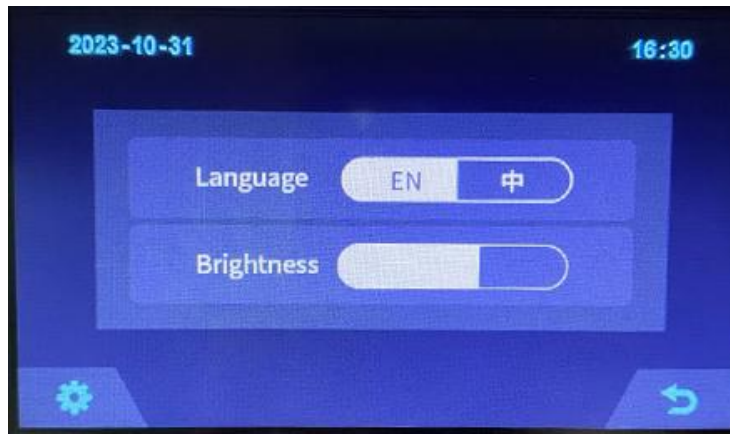

### 6.8 set up

Click [Settings] to enter the settings interface, which includes language settings and brightness settings. Click to  return to the upper level interface.



### 6.9 Fault information interface

Click on the main interface  to enter the fault information interface, where you can view the fault name and time of occurrence. Swipe left and right to check to  see more faults, click to return to the higher-level interface.

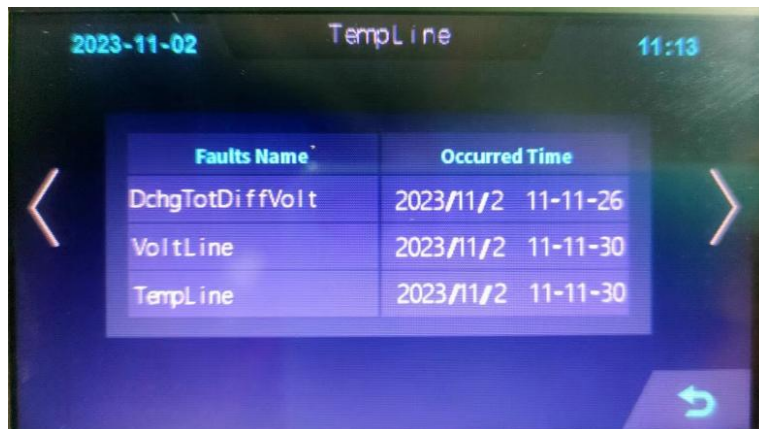

## 7 Maintenance and upgrade



**Warning!** Improper decommissioning may cause damage to the equipment and/or battery inverter.

Before maintenance, ensure that YP-HV 20-50 is decommissioned according to relevant provisions.

Note: All maintenance work shall comply with local applicable regulations and standards.

- Using the monitoring software, check whether the SoC, SoH, battery voltage and temperature of the battery module are abnormal.
- Shut down and restart YP-HV 20-50 once a year.

Note: If the system is installed in a polluted environment, maintenance and cleaning must be carried out at short intervals.

Note: Clean the battery rack with a dry-cleaning cloth. Ensure that no moisture comes into contact with the battery connections. Do not use solvents.

- ① To ensure the battery service life, the storage temperature shall be kept between 0°C~35°C.
- ② The battery shall be cycled at least once every 6 months.

## 8. Disposal

Observe applicable regulations on waste battery disposal. Immediately stop the use of damaged batteries. Please contact your installer or sales partner before disposal. Ensure that the battery is not exposed to moisture or direct sunlight.

### **Attention:**

1. Do not dispose of batteries and rechargeable batteries as domestic waste!

You are legally obliged to return used batteries and rechargeable batteries.

2. Waste batteries may contain pollutants that can damage the environment or your health if improperly stored or handled.

3. Batteries also contain iron, lithium and other important raw materials, which can be recycled.

